



REPUBLIC OF THE PHILIPPINES
METRO COTABATO WATER DISTRICT
Governor Gutierrez Avenue
Cotabato City

PHILIPPINE BIDDING DOCUMENTS

**Supply and Delivery of 1 Lot Various
Materials and Fittings**

PR#23-01-0034

**Sixth Edition
February 2023**

Table of Contents

Glossary of Acronyms, Terms, and Abbreviations	2
Section I. Invitation to Bid	5
Section II. Instructions to Bidders	8
1. Scope of Bid	9
2. Funding Information	9
3. Bidding Requirements	9
4. Corrupt, Fraudulent, Collusive, and Coercive Practices	9
5. Eligible Bidders	9
6. Origin of Goods	10
7. Subcontracts	10
8. Pre-Bid Conference	10
9. Clarification and Amendment of Bidding Documents	10
10. Documents comprising the Bid: Eligibility and Technical Components	11
11. Documents comprising the Bid: Financial Component	11
12. Bid Prices	11
13. Bid and Payment Currencies	12
14. Bid Security	12
15. Sealing and Marking of Bids	12
16. Deadline for Submission of Bids	13
17. Opening and Preliminary Examination of Bids	13
18. Domestic Preference	13
19. Detailed Evaluation and Comparison of Bids	13
20. Post-Qualification	14
21. Signing of the Contract	14
Section III. Bid Data Sheet	15
Section IV. General Conditions of Contract	17
1. Scope of Contract	18
2. Advance Payment and Terms of Payment	18
3. Performance Security	18
4. Inspection and Tests	18
5. Warranty	19
6. Liability of the Supplier	19
Section V. Special Conditions of Contract	20
Section VI. Schedule of Requirements	25
Section VIII. Checklist of Technical and Financial Documents	38

Glossary of Acronyms, Terms, and Abbreviations

ABC – Approved Budget for the Contract.

BAC – Bids and Awards Committee.

Bid – A signed offer or proposal to undertake a contract submitted by a bidder in response to and in consonance with the requirements of the bidding documents. Also referred to as *Proposal* and *Tender*. (2016 revised IRR, Section 5[c])

Bidder – Refers to a contractor, manufacturer, supplier, distributor and/or consultant who submits a bid in response to the requirements of the Bidding Documents. (2016 revised IRR, Section 5[d])

Bidding Documents – The documents issued by the Procuring Entity as the bases for bids, furnishing all information necessary for a prospective bidder to prepare a bid for the Goods, Infrastructure Projects, and/or Consulting Services required by the Procuring Entity. (2016 revised IRR, Section 5[e])

BIR – Bureau of Internal Revenue.

BSP – Bangko Sentral ng Pilipinas.

Consulting Services – Refer to services for Infrastructure Projects and other types of projects or activities of the GOP requiring adequate external technical and professional expertise that are beyond the capability and/or capacity of the GOP to undertake such as, but not limited to: (i) advisory and review services; (ii) pre-investment or feasibility studies; (iii) design; (iv) construction supervision; (v) management and related services; and (vi) other technical services or special studies. (2016 revised IRR, Section 5[i])

CDA - Cooperative Development Authority.

Contract – Refers to the agreement entered into between the Procuring Entity and the Supplier or Manufacturer or Distributor or Service Provider for procurement of Goods and Services; Contractor for Procurement of Infrastructure Projects; or Consultant or Consulting Firm for Procurement of Consulting Services; as the case may be, as recorded in the Contract Form signed by the parties, including all attachments and appendices thereto and all documents incorporated by reference therein.

CIF – Cost Insurance and Freight.

CIP – Carriage and Insurance Paid.

CPI – Consumer Price Index.

DDP – Refers to the quoted price of the Goods, which means “delivered duty paid.”

DTI – Department of Trade and Industry.

EXW – Ex works.

FCA – “Free Carrier” shipping point.

FOB – “Free on Board” shipping point.

Foreign-funded Procurement or Foreign-Assisted Project– Refers to procurement whose funding source is from a foreign government, foreign or international financing institution as specified in the Treaty or International or Executive Agreement. (2016 revised IRR, Section 5[b]).

Framework Agreement – Refers to a written agreement between a procuring entity and a supplier or service provider that identifies the terms and conditions, under which specific purchases, otherwise known as “Call-Offs,” are made for the duration of the agreement. It is in the nature of an option contract between the procuring entity and the bidder(s) granting the procuring entity the option to either place an order for any of the goods or services identified in the Framework Agreement List or not buy at all, within a minimum period of one (1) year to a maximum period of three (3) years. (GPPB Resolution No. 27-2019)

GFI – Government Financial Institution.

GOCC – Government-owned and/or –controlled corporation.

Goods – Refer to all items, supplies, materials and general support services, except Consulting Services and Infrastructure Projects, which may be needed in the transaction of public businesses or in the pursuit of any government undertaking, project or activity, whether in the nature of equipment, furniture, stationery, materials for construction, or personal property of any kind, including non-personal or contractual services such as the repair and maintenance of equipment and furniture, as well as trucking, hauling, janitorial, security, and related or analogous services, as well as procurement of materials and supplies provided by the Procuring Entity for such services. The term “related” or “analogous services” shall include, but is not limited to, lease or purchase of office space, media advertisements, health maintenance services, and other services essential to the operation of the Procuring Entity. (2016 revised IRR, Section 5[r])

GOP – Government of the Philippines.

GPPB – Government Procurement Policy Board.

INCOTERMS – International Commercial Terms.

Infrastructure Projects – Include the construction, improvement, rehabilitation, demolition, repair, restoration or maintenance of roads and bridges, railways, airports, seaports, communication facilities, civil works components of information technology projects, irrigation, flood control and drainage, water supply, sanitation, sewerage and solid waste management systems, shore protection, energy/power and electrification facilities, national

buildings, school buildings, hospital buildings, and other related construction projects of the government. Also referred to as *civil works or works*. (2016 revised IRR, Section 5[u])

LGUs – Local Government Units.

NFCC – Net Financial Contracting Capacity.

NGA – National Government Agency.

PhilGEPS - Philippine Government Electronic Procurement System.

Procurement Project – refers to a specific or identified procurement covering goods, infrastructure project or consulting services. A Procurement Project shall be described, detailed, and scheduled in the Project Procurement Management Plan prepared by the agency which shall be consolidated in the procuring entity's Annual Procurement Plan. (GPPB Circular No. 06-2019 dated 17 July 2019)

PSA – Philippine Statistics Authority.

SEC – Securities and Exchange Commission.

SLCC – Single Largest Completed Contract.

Supplier – refers to a citizen, or any corporate body or commercial company duly organized and registered under the laws where it is established, habitually established in business and engaged in the manufacture or sale of the merchandise or performance of the general services covered by his bid. (Item 3.8 of GPPB Resolution No. 13-2019, dated 23 May 2019). Supplier as used in these Bidding Documents may likewise refer to a distributor, manufacturer, contractor, or consultant.

UN – United Nations.

Section I. Invitation to Bid



REPUBLIC OF THE PHILIPPINES
METRO COTABATO WATER DISTRICT
Governor Gutierrez Avenue
Cotabato City

INVITATION TO BID FOR
Supply and Delivery of 1 Lot Various Materials and Fittings

1. The Metro Cotabato Water District (MCWD), through the MCWD 2023 Corporate Budget approved by Board of Directors intends to apply the sum of **Three Million Eight Hundred Eighty Two Thousand Seven Hundred Sixty Nine Pesos and Fifty Centavos Only (PhP3,882,769.50)** being the ABC to payments under the contract for **Supply and Delivery of 1 Lot Various Materials and Fittings (PR#23-01-0034)**. Bids received in excess of the ABC shall be automatically rejected at bid opening.
2. The Metro Cotabato Water District now invites bids for the above Procurement Project. Delivery of the Goods is required within **sixty (60) calendar days** from the issuance of Notice to Proceed. Bidders should have completed, within five (5) years from the date of submission and receipt of bids, a contract similar to the Project. The description of an eligible bidder is contained in the Bidding Documents, particularly, in Section II (Instructions to Bidders).
3. Bidding will be conducted through open competitive bidding procedures using a non-discretionary "*pass/fail*" criterion as specified in the 2016 revised Implementing Rules and Regulations (IRR) of Republic Act (RA) No. 9184.

Bidding is open to all interested bidders, whether local or foreign, subject to the conditions for eligibility provided in the 2016 revised IRR of RA No. 9184.
4. Prospective Bidders may obtain further information from Metro Cotabato Water District and inspect the Bidding Documents at the address given below during office hours from 8:00 a.m. to 5:00 p.m.
5. A complete set of Bidding Documents may be acquired by interested Bidders on **February 02, 2023** from the given address and website(s) below from the address below and upon payment of a non-refundable fee for the Bidding Documents, pursuant to the latest Guidelines issued by the GPPB, in the amount of **Five Thousand Pesos (P5,000.00)**. The Procuring Entity shall allow the bidder to present its proof of payment for the fees it will be presented in person; by facsimile; or through electronic means.

6. The Metro Cotabato Water District will hold a Pre-Bid Conference¹ on **February 10, 2023 @ 2:00 p.m.** at MCWD BAC Room and/or through video conferencing via Zoom, which shall be open to prospective bidders.
7. Bids must be duly received by the BAC Secretariat through manual submission at the office address indicated below on or before **February 22, 2023 @ 10:00 a.m.** Late bids shall not be accepted.
8. All Bids must be accompanied by a bid security in any of the acceptable forms and in the amount stated in **ITB** Clause 14.
9. Bid opening shall be on **February 22, 2023 @ 10:00 a.m.** at the given address below MCWD BAC Room Gov. Gutierrez Avenue, Cotabato City via Zoom. Bids will be opened in the presence of the bidders' representatives who choose to attend the activity.
10. Bidders who opt to attend physically the pre-bid conference and bid opening conference are advised to secure the necessary / requisite travel documents required by the Local Government Unit (LGU) concerned at their own expense, and shall submit to the precautionary measures being implemented within MCWD premises.
11. The Metro Cotabato Water District reserves the right to reject any and all bids, declare a failure of bidding, or not award the contract at any time prior to contract award in accordance with Sections 35.6 and 41 of the 2016 revised IRR of RA No. 9184, without thereby incurring any liability to the affected bidder or bidders.
12. For further information, please refer to:

MS. ROSALIE JUNGCO-DELA CRUZ
BAC Secretariat Head
Metro Cotabato Water District
Governor Gutierrez, Avenue, Cotabato City
TeleFax No. (064) 421-3009
E-Mail Address: mcwd_procurement@yahoo.com

You may visit the following websites:

For downloading of Bidding Documents: metrocotabatowd.gov.ph

February 02, 2023

ENGR. WINSTON L. SAPAL
Chairperson, MCWD BAC

¹ May be deleted in case the ABC is less than One Million Pesos (PhP1,000,000) where the Procuring Entity may not hold a Pre-Bid Conference.

Section II. Instructions to Bidders

1. Scope of Bid

The Procuring Entity, Metro Cotabato Water District wishes to receive Bids for the **Supply and Delivery of 1 Lot Various Materials and Fittings (PR#23-01-0034)**.

The Procurement Project (referred to herein as “Project”) is composed of **Supply and Delivery of 1 Lot Various Materials and Fittings, the details of which are described in Section VII (Technical Specifications)**.

2. Funding Information

2.1. The GOP through the source of funding as indicated below for 2023 in the amount of **Php3,882,769.50**

2.2. The source of funding is: GOCC – MCWD Corporate Operating Budget.

3. Bidding Requirements

The Bidding for the Project shall be governed by all the provisions of RA No. 9184 and its 2016 revised IRR, including its Generic Procurement Manuals and associated policies, rules and regulations as the primary source thereof, while the herein clauses shall serve as the secondary source thereof.

Any amendments made to the IRR and other GPPB issuances shall be applicable only to the ongoing posting, advertisement, or **IB** by the BAC through the issuance of a supplemental or bid bulletin.

The Bidder, by the act of submitting its Bid, shall be deemed to have verified and accepted the general requirements of this Project, including other factors that may affect the cost, duration and execution or implementation of the contract, project, or work and examine all instructions, forms, terms, and project requirements in the Bidding Documents.

4. Corrupt, Fraudulent, Collusive, and Coercive Practices

The Procuring Entity, as well as the Bidders and Suppliers, shall observe the highest standard of ethics during the procurement and execution of the contract. They or through an agent shall not engage in corrupt, fraudulent, collusive, coercive, and obstructive practices defined under Annex “I” of the 2016 revised IRR of RA No. 9184 or other integrity violations in competing for the Project.

5. Eligible Bidders

5.1. Only Bids of Bidders found to be legally, technically, and financially capable will be evaluated.

- 5.2. Foreign ownership limited to those allowed under the rules may participate in this Project.
- 5.3. Pursuant to Section 23.4.1.3 of the 2016 revised IRR of RA No.9184, the Bidder shall have an SLCC that is at least one (1) contract similar to the Project the value of which, adjusted to current prices using the PSA's CPI, must be at least equivalent to:
 - a. For the procurement of Non-expendable Supplies and Services: The Bidder must have completed a single contract that is similar to this Project, equivalent to at least fifty percent (50%) of the ABC.
- 5.4. The Bidders shall comply with the eligibility criteria under Section 23.4.1 of the 2016 IRR of RA No. 9184.

6. Origin of Goods

There is no restriction on the origin of goods other than those prohibited by a decision of the UN Security Council taken under Chapter VII of the Charter of the UN, subject to Domestic Preference requirements under **ITB** Clause 18.

7. Subcontracts

- 7.1. The Bidder may subcontract portions of the Project to the extent allowed by the Procuring Entity as stated herein, but in no case more than twenty percent (20%) of the Project.

The Procuring Entity has prescribed that:

- a. Subcontracting is not allowed.

8. Pre-Bid Conference

The Procuring Entity will hold a pre-bid conference for this Project on the specified date and time and either at its physical address at Governor Gutierrez Avenue, Cotabato City and/or through video conferencing / webcasting via Zoom as indicated in paragraph 6 of the **IB**.

9. Clarification and Amendment of Bidding Documents

Prospective bidders may request for clarification on and/or interpretation of any part of the Bidding Documents. Such requests must be in writing and received by the Procuring Entity, either at its given address or through electronic mail indicated in the **IB**, at least ten (10) calendar days before the deadline set for the submission and receipt of Bids.

10. Documents comprising the Bid: Eligibility and Technical Components

- 10.1. The first envelope shall contain the eligibility and technical documents of the Bid as specified in **Section VIII (Checklist of Technical and Financial Documents)**.
- 10.2. The Bidder's SLCC as indicated in **ITB** Clause 5.3 should have been completed within five (5) years prior to the deadline for the submission and receipt of bids.
- 10.3. If the eligibility requirements or statements, the bids, and all other documents for submission to the BAC are in foreign language other than English, it must be accompanied by a translation in English, which shall be authenticated by the appropriate Philippine foreign service establishment, post, or the equivalent office having jurisdiction over the foreign bidder's affairs in the Philippines. Similar to the required authentication above, for Contracting Parties to the Apostille Convention, only the translated documents shall be authenticated through an apostille pursuant to GPPB Resolution No. 13-2019 dated 23 May 2019. The English translation shall govern, for purposes of interpretation of the bid.

11. Documents comprising the Bid: Financial Component

- 11.1. The second bid envelope shall contain the financial documents for the Bid as specified in **Section VIII (Checklist of Technical and Financial Documents)**.
- 11.2. If the Bidder claims preference as a Domestic Bidder or Domestic Entity, a certification issued by DTI shall be provided by the Bidder in accordance with Section 43.1.3 of the 2016 revised IRR of RA No. 9184.
- 11.3. Any bid exceeding the ABC indicated in paragraph 1 of the **IB** shall not be accepted.

12. Bid Prices

- 12.1. Prices indicated on the Price Schedule shall be entered separately in the following manner:
 - a. For Goods offered from within the Procuring Entity's country:
 - i. The price of the Goods quoted EXW (ex-works, ex-factory, ex-warehouse, ex-showroom, or off-the-shelf, as applicable);
 - ii. The cost of all customs duties and sales and other taxes already paid or payable;

- iii. The cost of transportation, insurance, and other costs incidental to delivery of the Goods to their final destination; and
 - iv. The price of other (incidental) services, if any, listed in e.
- b. For Goods offered from abroad:
- i. Unless otherwise stated in the **BDS**, the price of the Goods shall be quoted delivered duty paid (DDP) with the place of destination in the Philippines as specified in the **BDS**. In quoting the price, the Bidder shall be free to use transportation through carriers registered in any eligible country. Similarly, the Bidder may obtain insurance services from any eligible source country.
 - ii. The price of other (incidental) services, if any, as listed in **Section VII (Technical Specifications)**.

13. Bid and Payment Currencies

- 13.1. For Goods that the Bidder will supply from outside the Philippines, the bid prices may be quoted in the local currency or tradeable currency accepted by the BSP at the discretion of the Bidder. However, for purposes of bid evaluation, Bids denominated in foreign currencies, shall be converted to Philippine currency based on the exchange rate as published in the BSP reference rate bulletin on the day of the bid opening.
- 13.2. Payment of the contract price shall be made in: Philippine Pesos.

14. Bid Security

- 14.1. The Bidder shall submit a Bid Securing Declaration² or any form of Bid Security in the amount indicated in the **BDS**, which shall be not less than the percentage of the ABC in accordance with the schedule in the **BDS**.
- 14.2. The Bid and bid security shall be valid until **June 21, 2023**. Any Bid not accompanied by an acceptable bid security shall be rejected by the Procuring Entity as non-responsive.

15. Sealing and Marking of Bids

Each Bidder shall submit one copy of the first and second components of its Bid.

² In the case of Framework Agreement, the undertaking shall refer to entering into contract with the Procuring Entity and furnishing of the performance security or the performance securing declaration within ten (10) calendar days from receipt of Notice to Execute Framework Agreement.

The Procuring Entity may request additional hard copies and/or electronic copies of the Bid. However, failure of the Bidders to comply with the said request shall not be a ground for disqualification.

If the Procuring Entity allows the submission of bids through online submission or any other electronic means, the Bidder shall submit an electronic copy of its Bid, which must be digitally signed. An electronic copy that cannot be opened or is corrupted shall be considered non-responsive and, thus, automatically disqualified.

16. Deadline for Submission of Bids

16.1. The Bidders shall submit on the specified date and time and either at its physical address or through online submission as indicated in paragraph 7 of the **IB**.

17. Opening and Preliminary Examination of Bids

17.1. The BAC shall open the Bids in public at the time, on the date, and at the place specified in paragraph 9 of the **IB**. The Bidders' representatives who are present shall sign a register evidencing their attendance. In case videoconferencing, webcasting or other similar technologies will be used, attendance of participants shall likewise be recorded by the BAC Secretariat.

In case the Bids cannot be opened as scheduled due to justifiable reasons, the rescheduling requirements under Section 29 of the 2016 revised IRR of RA No. 9184 shall prevail.

17.2. The preliminary examination of bids shall be governed by Section 30 of the 2016 revised IRR of RA No. 9184.

18. Domestic Preference

18.1. The Procuring Entity will grant a margin of preference for the purpose of comparison of Bids in accordance with Section 43.1.2 of the 2016 revised IRR of RA No. 9184.

19. Detailed Evaluation and Comparison of Bids

19.1. The Procuring BAC shall immediately conduct a detailed evaluation of all Bids rated "*passed*," using non-discretionary pass/fail criteria. The BAC shall consider the conditions in the evaluation of Bids under Section 32.2 of the 2016 revised IRR of RA No. 9184.

19.2. If the Project allows partial bids, bidders may submit a proposal on any of the lots or items, and evaluation will be undertaken on a per lot or item basis, as the case maybe. In this case, the Bid Security as required by **ITB** Clause 15 shall be submitted for each lot or item separately.

- 19.3. The descriptions of the lots or items shall be indicated in **Section VII (Technical Specifications)**, although the ABCs of these lots or items are indicated in the **BDS** for purposes of the NFCC computation pursuant to Section 23.4.2.6 of the 2016 revised IRR of RA No. 9184. The NFCC must be sufficient for the total of the ABCs for all the lots or items participated in by the prospective Bidder.
- 19.4. The Project shall be awarded as follows:
- One Project having several items that shall be awarded as one contract.
- 19.5. Except for bidders submitting a committed Line of Credit from a Universal or Commercial Bank in lieu of its NFCC computation, all Bids must include the NFCC computation pursuant to Section 23.4.1.4 of the 2016 revised IRR of RA No. 9184, which must be sufficient for the total of the ABCs for all the lots or items participated in by the prospective Bidder. For bidders submitting the committed Line of Credit, it must be at least equal to ten percent (10%) of the ABCs for all the lots or items participated in by the prospective Bidder.

20. Post-Qualification

Within a non-extendible period of five (5) calendar days from receipt by the Bidder of the of the notice from the BAC that it submitted the Lowest Calculated Bid, the Bidder shall submit its latest income and business tax returns filed and paid through the BIR Electronic Filing and Payment System (eFPS), and other appropriate licenses and permits required by law and stated in the **BDS**.

21. Signing of the Contract

- 21.1. The documents required in Section 37.2 of the 2016 revised IRR of RA No. 9184 shall form part of the Contract. Additional Contract documents are indicated in the **BDS**.
- 21.2. The Procuring Entity shall enter into a Framework Agreement with the successful Bidder within the same ten (10) calendar day period provided that all the documentary requirements are complied with.

Section III. Bid Data Sheet

Bid Data Sheet

ITB Clause	
5.3	<p>For this purpose, contracts similar to the Project shall be:</p> <ul style="list-style-type: none"> a. For this purpose, similar contracts shall refer to contracts which have the same major categories of work, provided that its total cost is at least 50% of the ABC. b. completed within five (5) years prior to the deadline for the submission and receipt of bids.
7.1	Not Applicable
12	The price of the Goods shall be quoted DDP at MCWD Compound – Gov. Gutierrez Ave. Rosary Heights 7, / Ramon Rabago Street, Cotabato City.
14.1	<p>The bid security shall be in the form of a Bid Securing Declaration, or any of the following forms and amounts:</p> <ul style="list-style-type: none"> a. The amount of not less than <u>PhP77,655.39</u> if bid security is in cash, cashier's/manager's check, bank draft/guarantee or irrevocable letter of credit; or b. The amount of not less than <u>PhP194,138.48</u> if bid security is in Surety Bond.
15.0	Each Bidder shall submit one (1) original and two (2) duplicate copies of the first and second components of its bid.
19.3	Supply and Delivery of 1 lot Various Materials and Fittings
20	No further instructions.
21.2	No further instruction

Section IV. General Conditions of Contract

1. **Scope of Contract**

This Contract shall include all such items, although not specifically mentioned, that can be reasonably inferred as being required for its completion as if such items were expressly mentioned herein. All the provisions of RA No. 9184 and its 2016 revised IRR, including the Generic Procurement Manual, and associated issuances, constitute the primary source for the terms and conditions of the Contract, and thus, applicable in contract implementation. Herein clauses shall serve as the secondary source for the terms and conditions of the Contract.

This is without prejudice to Sections 74.1 and 74.2 of the 2016 revised IRR of RA No. 9184 allowing the GPPB to amend the IRR, which shall be applied to all procurement activities, the advertisement, posting, or invitation of which were issued after the effectivity of the said amendment.

Additional requirements for the completion of this Contract shall be provided in the **Special Conditions of Contract (SCC)**.

2. **Advance Payment and Terms of Payment**

2.1. Advance payment of the contract amount is provided under Annex “D” of the revised 2016 IRR of RA No. 9184.

2.2. The Procuring Entity is allowed to determine the terms of payment on the partial or staggered delivery of the Goods procured, provided such partial payment shall correspond to the value of the goods delivered and accepted in accordance with prevailing accounting and auditing rules and regulations. The terms of payment are indicated in the **SCC**.

3. **Performance Security**

Within ten (10) calendar days from receipt of the Notice of Award by the Bidder from the Procuring Entity but in no case later than prior to the signing of the Contract by both parties, the successful Bidder shall furnish the performance security in any of the forms prescribed in Section 39 of the 2016 revised IRR of RA No. 9184.

4. **Inspection and Tests**

The Procuring Entity or its representative shall have the right to inspect and/or to test the Goods to confirm their conformity to the Project. In addition to tests in the **SCC**, **Section VII (Technical Specifications)** shall specify what inspections and/or tests the Procuring Entity requires, and where they are to be conducted. The Procuring Entity shall notify the Supplier in writing, in a timely manner, of the identity of any representatives retained for these purposes.

All reasonable facilities and assistance for the inspection and testing of Goods, including access to drawings and production data, shall be provided by the Supplier to the authorized inspectors at no charge to the Procuring Entity.

5. Warranty

- 6.1. In order to assure that manufacturing defects shall be corrected by the Supplier, a warranty shall be required from the Supplier as provided under Section 62.1 of the 2016 revised IRR of RA No. 9184.
- 6.2. The Procuring Entity shall promptly notify the Supplier in writing of any claims arising under this warranty. Upon receipt of such notice, the Supplier shall, repair or replace the defective Goods or parts thereof without cost to the Procuring Entity, pursuant to the Generic Procurement Manual.

6. Liability of the Supplier

The Supplier's liability under this Contract shall be as provided by the laws of the Republic of the Philippines.

If the Supplier is a joint venture, all partners to the joint venture shall be jointly and severally liable to the Procuring Entity.

Section V. Special Conditions of Contract

Special Conditions of Contract

GCC Clause	
1	<p>Delivery and Documents –</p> <p>For purposes of the Contract, “EXW,” “FOB,” “FCA,” “CIF,” “CIP,” “DDP” and other trade terms used to describe the obligations of the parties shall have the meanings assigned to them by the current edition of INCOTERMS published by the International Chamber of Commerce, Paris. The Delivery terms of this Contract shall be as follows:</p> <p><i>[For Goods supplied from abroad, state:]</i> “The delivery terms applicable to the Contract are DDP delivered at MCWD – Gov. Gutierrez Avenue, Rosary Heights 7, / Ramon Rabago Street, Rosary Heights 13, Cotabato City. In accordance with INCOTERMS.”</p> <p><i>[For Goods supplied from within the Philippines, state:]</i> “The delivery terms applicable to this Contract are delivered at MCWD – Gov. Gutierrez Avenue, Rosary Heights 7, / Ramon Rabago Street, Rosary Heights 13, Cotabato City. Risk and title will pass from the Supplier to the Procuring Entity upon receipt and final acceptance of the Goods at their final destination.”</p> <p>Delivery of the Goods shall be made by the Supplier in accordance with the terms specified in Section VI (Schedule of Requirements).</p> <p>For purposes of this Clause the Procuring Entity’s Representative at the Project Site is Engr. Mohamad Ghazny A. Dimalen – End User.</p> <p>Incidental Services –</p> <p>The Supplier is required to provide all of the following services, including additional services, if any, specified in Section VI. Schedule of Requirements:</p>
	<p>The Contract price for the Goods shall include the prices charged by the Supplier for incidental services and shall not exceed the prevailing rates charged to other parties by the Supplier for similar services.</p> <p>Spare Parts –</p> <p>The Supplier is required to provide all of the following materials, notifications, and information pertaining to spare parts manufactured or distributed by the Supplier:</p>

	<p>a. such spare parts as the Procuring Entity may elect to purchase from the Supplier, provided that this election shall not relieve the Supplier of any warranty obligations under this Contract; and</p> <p>b. in the event of termination of production of the spare parts:</p> <ul style="list-style-type: none"> i. advance notification to the Procuring Entity of the pending termination, in sufficient time to permit the Procuring Entity to procure needed requirements; and ii. following such termination, furnishing at no cost to the Procuring Entity, the blueprints, drawings, and specifications of the spare parts, if requested. <p>The spare parts and other components required are listed in Section VI (Schedule of Requirements) and the cost thereof are included in the contract price.</p> <p>The Supplier shall carry sufficient inventories to assure ex-stock supply of consumable spare parts or components for the Goods for a period of three (3) years from the date of commissioning and acceptance.</p> <p>Spare parts or components shall be supplied as promptly as possible, but in any case, within one (1) month of placing the order.</p>
	<p>Packaging –</p> <p>The Supplier shall provide such packaging of the Goods as is required to prevent their damage or deterioration during transit to their final destination, as indicated in this Contract. The packaging shall be sufficient to withstand, without limitation, rough handling during transit and exposure to extreme temperatures, salt and precipitation during transit, and open storage. Packaging case size and weights shall take into consideration, where appropriate, the remoteness of the Goods’ final destination and the absence of heavy handling facilities at all points in transit.</p>
	<p>The packaging, marking, and documentation within and outside the packages shall comply strictly with such special requirements as shall be expressly provided for in the Contract, including additional requirements, if any, specified below, and in any subsequent instructions ordered by the Procuring Entity.</p> <p>The outer packaging must be clearly marked on at least four (4) sides as follows:</p> <p>Name of the Procuring Entity Name of the Supplier Contract Description</p>

	<p>Final Destination Gross weight Any special lifting instructions Any special handling instructions Any relevant HAZCHEM classifications</p> <p>A packaging list identifying the contents and quantities of the package is to be placed on an accessible point of the outer packaging if practical. If not practical the packaging list is to be placed inside the outer packaging but outside the secondary packaging.</p>
	<p>Transportation –</p> <p>Where the Supplier is required under Contract to deliver the Goods CIF, CIP, or DDP, transport of the Goods to the port of destination or such other named place of destination in the Philippines, as shall be specified in this Contract, shall be arranged and paid for by the Supplier, and the cost thereof shall be included in the Contract Price.</p> <p>Where the Supplier is required under this Contract to transport the Goods to a specified place of destination within the Philippines, defined as the Project Site, transport to such place of destination in the Philippines, including insurance and storage, as shall be specified in this Contract, shall be arranged by the Supplier, and related costs shall be included in the contract price.</p>
	<p>Where the Supplier is required under Contract to deliver the Goods CIF, CIP or DDP, Goods are to be transported on carriers of Philippine registry. In the event that no carrier of Philippine registry is available, Goods may be shipped by a carrier which is not of Philippine registry provided that the Supplier obtains and presents to the Procuring Entity certification to this effect from the nearest Philippine consulate to the port of dispatch. In the event that carriers of Philippine registry are available but their schedule delays the Supplier in its performance of this Contract the period from when the Goods were first ready for shipment and the actual date of shipment the period of delay will be considered force majeure.</p> <p>The Procuring Entity accepts no liability for the damage of Goods during transit other than those prescribed by INCOTERMS for DDP deliveries. In the case of Goods supplied from within the Philippines or supplied by domestic Suppliers risk and title will not be deemed to have passed to the Procuring Entity until their receipt and final acceptance at the final destination.</p>
	<p>Intellectual Property Rights –</p> <p>The Supplier shall indemnify the Procuring Entity against all third-party claims of infringement of patent, trademark, or industrial design rights arising from use of the Goods or any part thereof.</p>

2.2	Not Applicable
4	Not Applicable

Section VI. Schedule of Requirements

Schedule of Requirements

The delivery schedule expressed as weeks/months stipulates hereafter a delivery date which is the date of delivery to the project site.

Item Number	Description	Quantity	Total	Delivered, Weeks/Months
1	Supply and Delivery of Various Materials and Fittings	1	Lot	2 months

I hereby certify to comply and deliver all the above requirements.

Name of Company/Bidder

Signature over Printed Name of Representative

Date

Section VII. Technical Specifications

Technical Specifications

Item	Specification	Statement of Compliance
		<p><i>[Bidders must state here either “Comply” or “Not Comply” against each of the individual parameters of each Specification stating the corresponding performance parameter of the equipment offered. Statements of “Comply” or “Not Comply” must be supported by evidence in a Bidders Bid and cross-referenced to that evidence. Evidence shall be in the form of manufacturer’s un-amended sales literature, unconditional statements of specification and compliance issued by the manufacturer, samples, independent test data etc., as appropriate. A statement that is not supported by evidence or is subsequently found to be contradicted by the evidence presented will render the Bid under evaluation liable for rejection. A statement either in the Bidder’s statement of compliance or the supporting evidence that is found to be false either during Bid evaluation, post-qualification or the execution of the Contract may be regarded as fraudulent and render the</i></p>

		<i>Bidder or supplier liable for prosecution subject to the applicable laws and issuances.]</i>
	Supply and Delivery of 1 lot Various Materials and Fittings	
I.	Specifications	
1	116 pcs. – uPVC Pipe 8"Ø x 6.0m, S-8, c150 w/ RR	
2	1 pc. – uPVC Pipe 6"Ø x 6.0m, S-8, c150 w/ RR	
3	19 pcs. – uPVC Pipe 4"Ø x 6.0m, S-8, c150 w/ RR	
4	1 pc. – uPVC Pipe 2"Ø x 6.0m, S-8, c150 w/ RR	
5	4 pcs. – uPVC Bend 8"Ø x 45° (DH), S-8, C150 w/ RR	
6	2 pcs. – uPVC Bend 8"Ø x 22.5° (DH), S-8, C150 w/ RR	
7	4 pcs. – uPVC Bend 4"Ø x 45° (DH), S-8, C150 w/ RR	
8	2 pcs. – uPVC Bend 2"Ø x 45° (DH), S-8, C150 w/ RR	
9	1 pc. – CI Tee Reducer, 8"Ø x 4"Ø (M/F) with Stainless Steel Bolts, Nuts and Plain Washers	
10	2 pcs. – CI Tee Reducer 8"Ø x 4"Ø (F/F)	
11	1 pc. – CI Tee Reducer, 8"Ø x 4"Ø (F/M) with Stainless Steel Bolts, Nuts and Plain Washers	
12	2 pcs. – CI Reducer 4"Ø x 2"Ø (F/M) with Stainless Steel Bolts, Nuts and Plain Washers (for uPVC Pipe)	
13	5 pcs. – CI Flange Adapter, 8"Ø (F/M) with Stainless Steel Bolts, Nuts and Plain Washers (for uPVC Pipe)	
14	3 pcs. – CI Flange Adapter, 4"Ø (F/M) with Stainless Steel Bolts, Nuts and Plain Washers (for uPVC Pipe)	
15	6 pcs. – CI Sleeve Type Coupling 8"Ø x 150mm(6") with Stainless Steel Bolts, Nuts and Plain Washers, Full Thread (for uPVC Pipe)	

16	4 pcs. – CI Sleeve Type Coupling 4"Ø x 150mm(6") with Stainless Steel Bolts, Nuts and Plain Washers, Full Thread (for uPVC Pipe)	
17	2 pcs. – CI Sleeve Type Coupling 2"Ø x 150mm(6") with Stainless Steel Bolts, Nuts and Plain Washers, Full Thread (for uPVC Pipe)	
18	2 pcs. – CI Bend 8"Ø x 90° (M/M) with Stainless Steel Bolts Nuts & Plain Washers (for uPVC Pipe)	
19	2 pcs. – CI Bend 8"Ø x 45° (M/M) with Stainless Steel Bolts Nuts & Plain Washers (for uPVC Pipe)	
20	3 pcs. – Butterfly Valve, 8"Ø with underground gear & 2" nut (Wafer Type)	
21	5 pcs. – Butterfly Valve, 4"Ø with underground gear & 2" nut (Wafer Type)	
22	40 pcs. – Stainless Steel Bolts with Nuts & Plain Washers 25mmØ x 100mm	
23	24 pcs. – Stainless Steel Tension Bolts with Nuts & Plain Washers 19mmØ x 150mm	
24	16 pcs. – Stainless Steel Bolts with Nuts & Plain Washers 19mmØ x 75mm	
25	28 pcs. – Stainless Steel Tension Bolts with Nuts & Plain Washers 16mmØ x 150mm	
26	3 pcs. – CI Valve Box Cover 6"Ø	
27	2 pcs. – CI Mechanical Cap Plug, 8"Ø with Stainless Steel Bolts, Nuts and Plain Washers	
28	2 pcs. – CI Mechanical Cap Plug, 4"Ø with Stainless Steel Bolts, Nuts and Plain Washers	
29	36 pcs. – CI Saddle Clamp 8"Ø x 1"Ø with Stainless Steel Bolts, Nuts and Plain Washers	
30	12 pcs. – CI Saddle Clamp 4"Ø x 1"Ø with Stainless Steel Bolts, Nuts and Plain Washers	
31	2 pcs. – Steel Flange Ring 8"Ø	
32	1 pc. – Rubber Sheet (for Rubber Gasket) 1m x 1m x 1/4"thk.	

33	220 mtrs. – HDPE 1"Ø (SDR - 9) (ISO)	
34	105 pcs. – Corporation Replacement Piece 1"Ø, Compression type, ISO (330gms/pc)	
II.	Terms and Conditions	
	1. All items must include the freight/delivery expense.	
	2. All items shall be delivered at MCWD Compound, Gov. Gutierrez Avenue, Rosary Heights 7, / Ramon Rabago Street., Rosary Heights 13, Cotabato City.	
	3. All items must be delivered within sixty days (60) calendar days upon receipt of approved Purchase Order/Notice to Proceed.	
	4. The items must have a minimum warranty period of one (1) year	
	5. Bidder must include in the Bid form their breakdown of prices for each item.	
	6. Bidder must attached sample picture of Items # 1, 5, 9, 13, 15, 19, 20, 27 and 29 of Section VII / brochure or any evidence in form of manufacturer’s un-amended sales literature, failure to submit shall be subject for disqualification.	
	7. All communications during procurement period must be submitted through MCWD Procurement Section or email @ mcwd_procurement@yahoo.com.	

NOTE: Bidders must state either “COMPLY” or “NOT COMPLY” or any equivalent term in the column “Statement of Compliance” against each of the individual parameters of each “Specification”.

I hereby certify to comply with all the above Technical Specifications.

Name of Company/Bidder

Signature Over Printed Name of Representative

Date

ITEM 1 - 4

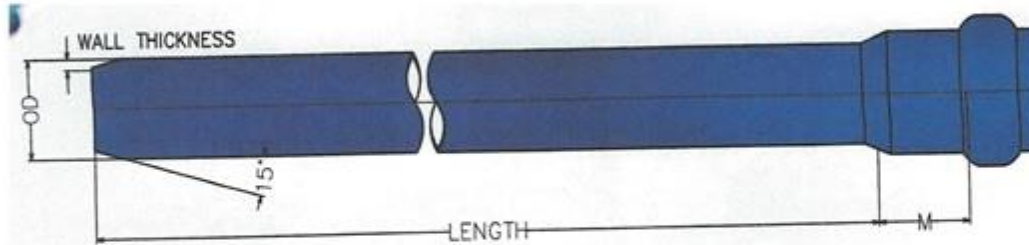

uPVC Pipes-PNS 65

Specification: PNS 65:1963
 ISO 4422 / 1452
 Color: Blue
 RAL 5012
 Jointing Method: PUSH-ON Type
 INTEGRAL FIXED SEAL TYPE

Advantages:
 -Economical and easy to install
 -Durable and weather resistant
 -High flow capacity
 -Chemical resistant

Nominal Size		Outside Diameter of Pipe	Effective Length (Le)	Wall Thickness-T (mm)	
				Series 8 (C-150)	
inches	mm	mm	mm	min	max
2	50	63	6000	3.6	4.16
4	100	110	6000	6.3	7.13
6	150	160	6000	9.2	10.32
8	200	225	6000	12.9	14.39

ITEM 5 - 8



uPVC Bend 90°



uPVC Bend 45°



uPVC Bend 22.5°

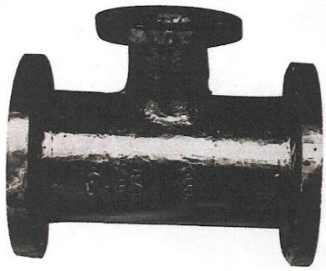

ITEM 11: CI Tee Reducer F/F

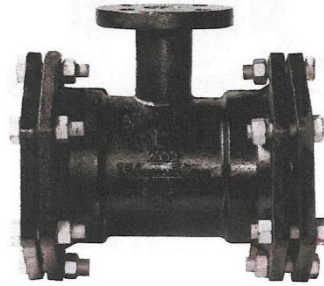

ITEM 9: CI Tee Reducer M/F

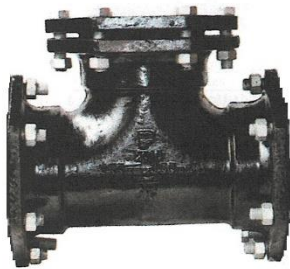

ITEM 10: CI Tee Reducer F/M



ITEM 12: CI Reducer F/M

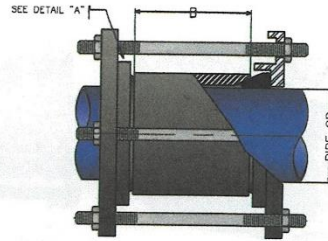

SIZE	PIPE OD PVC	T	B
50	63	10	140
100	110	13	140
200	225	15.2	140

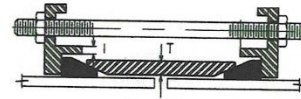

Detail "A"

ITEM 15-17: CI Sleeve Type Coupling



MJ 90 degree

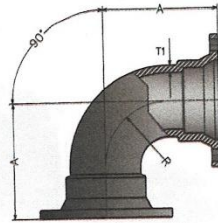

C.I. Bend Mechanical Type 90 Degree

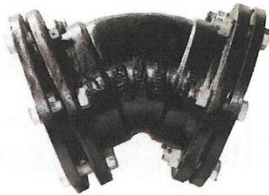

MJ 45 degree

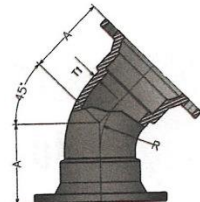

C.I. Bend Mechanical Type 45 Degree

ITEM 18-19: CI Bend M/M

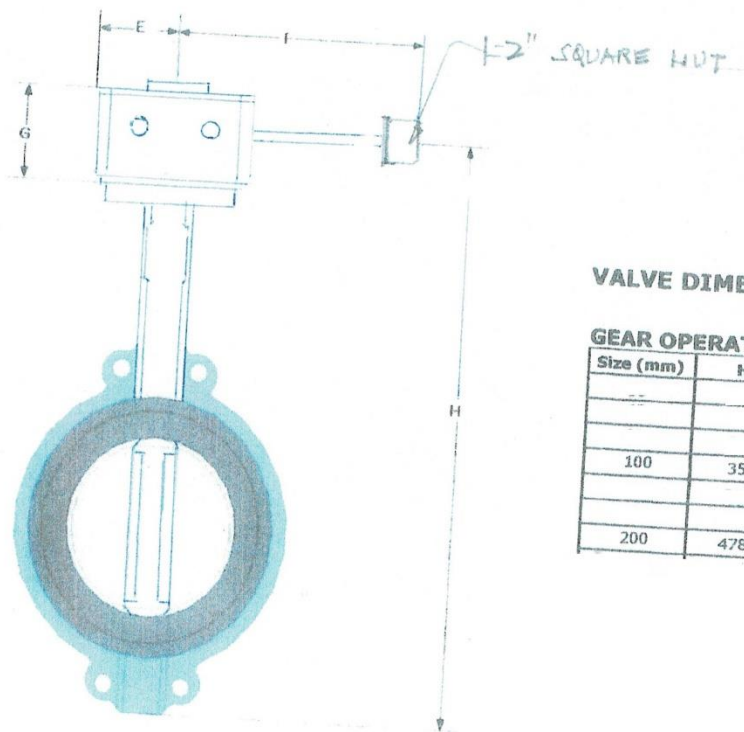

VALVE DIMENSION:

GEAR OPERATOR				
(unit: mm)				
Size (mm)	H	E	F	G
100	350	52.5	173.5	72
200	478	76	237	87

BUTTERFLY VALVE GEAR OPERATOR (WAFER TYPE)

ITEM 20-21: Butterfly Valve (Wafer Type)

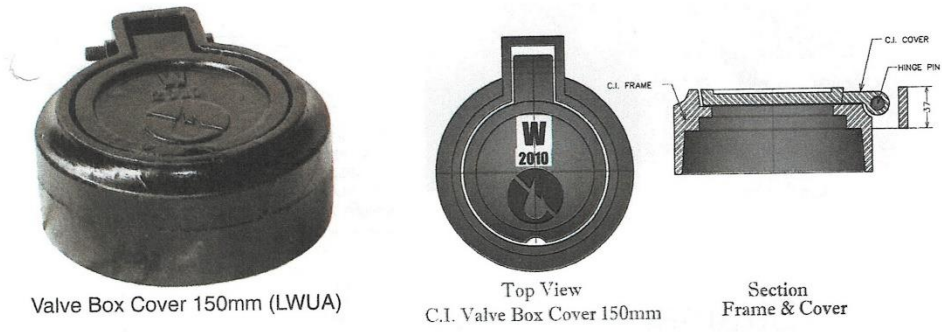

Valve Box Cover 150mm (LWUA)

Top View
C.I. Valve Box Cover 150mm

Section
Frame & Cover

ITEM 26: CI Valve Box Cover

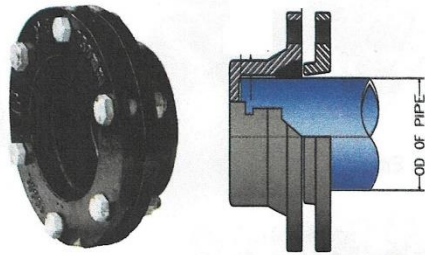

CI Mechanical Cap Plug

ITEM 27 -28



C. I. Saddle Clamp
ITEM 29 -30

NOMINAL PIPE SIZE	BOLT SIZE DIAMETER	OUTSIDE DIAMETER PVC PIPE
100	12	110
200	16	225

***Section VIII. Checklist of Technical and
Financial Documents***

Checklist of Technical and Financial Documents

I. TECHNICAL COMPONENT ENVELOPE

Class “A” Documents

Legal Documents

- (a) Valid PhilGEPS Registration Certificate (Platinum Membership) (all pages);
or
- (b) Registration certificate from Securities and Exchange Commission (SEC), Department of Trade and Industry (DTI) for sole proprietorship, or Cooperative Development Authority (CDA) for cooperatives or its equivalent document,
and
- (c) Mayor’s or Business permit issued by the city or municipality where the principal place of business of the prospective bidder is located, or the equivalent document for Exclusive Economic Zones or Areas;
and
- (d) Tax clearance per E.O. No. 398, s. 2005, as finally reviewed and approved by the Bureau of Internal Revenue (BIR).

Technical Documents

- (f) Statement of the prospective bidder of all its ongoing government and private contracts, including contracts awarded but not yet started, if any, whether similar or not similar in nature and complexity to the contract to be bid; **and**
- (g) Statement of the bidder’s Single Largest Completed Contract (SLCC) similar to the contract to be bid, except under conditions provided for in Sections 23.4.1.3 and 23.4.2.4 of the 2016 revised IRR of RA No. 9184, within the relevant period as provided in the Bidding Documents; **and**
- (h) Original copy of Bid Security. If in the form of a Surety Bond, submit also a certification issued by the Insurance Commission;
or
Original copy of Notarized Bid Securing Declaration; **and**
- (i) Conformity with the Technical Specifications, which may include production/delivery schedule, manpower requirements, and/or after-sales/parts, if applicable; **and**
- (j) Original duly signed Omnibus Sworn Statement (OSS);
and if applicable, Original Notarized Secretary’s Certificate in case of a corporation, partnership, or cooperative; or Original Special Power of Attorney of all members of the joint venture giving full power and authority to its officer to sign the OSS and do acts to represent the Bidder.

Financial Documents

- (k) The Supplier’s audited financial statements, showing, among others, the Supplier’s total and current assets and liabilities, stamped “received” by the BIR or its duly accredited and authorized institutions, for the preceding calendar year which should not be earlier than two (2) years from the date of bid submission; **and**

- (l) The prospective bidder's computation of Net Financial Contracting Capacity (NFCC);
or
A committed Line of Credit from a Universal or Commercial Bank in lieu of its NFCC computation.

Class "B" Documents

- (m) If applicable, a duly signed joint venture agreement (JVA) in case the joint venture is already in existence;
or
duly notarized statements from all the potential joint venture partners stating that they will enter into and abide by the provisions of the JVA in the instance that the bid is successful.

Other documentary requirements under RA No. 9184 (as applicable)

- (n) *[For foreign bidders claiming by reason of their country's extension of reciprocal rights to Filipinos]* Certification from the relevant government office of their country stating that Filipinos are allowed to participate in government procurement activities for the same item or product.
- (o) Certification from the DTI if the Bidder claims preference as a Domestic Bidder or Domestic Entity.

25 FINANCIAL COMPONENT ENVELOPE

- (a) Original of duly signed and accomplished Financial Bid Form; **and**
- (b) Original of duly signed and accomplished Price Schedule(s).

Bid Form for the Procurement of Goods

[shall be submitted with the Bid]

BID FORM

Date : _____

Project Identification No. : _____

To: *[name and address of Procuring Entity]*

Having examined the Philippine Bidding Documents (PBDs) including the Supplemental or Bid Bulletin Numbers *[insert numbers]*, the receipt of which is hereby duly acknowledged, we, the undersigned, offer to *[supply/deliver/perform]* *[description of the Goods]* in conformity with the said PBDs for the sum of *[total Bid amount in words and figures]* or the total calculated bid price, as evaluated and corrected for computational errors, and other bid modifications in accordance with the Price Schedules attached herewith and made part of this Bid. The total bid price includes the cost of all taxes, such as, but not limited to: *[specify the applicable taxes, e.g. (i) value added tax (VAT), (ii) income tax, (iii) local taxes, and (iv) other fiscal levies and duties]*, which are itemized herein or in the Price Schedules,

If our Bid is accepted, we undertake:

- a. to deliver the goods in accordance with the delivery schedule specified in the Schedule of Requirements of the Philippine Bidding Documents (PBDs);
- b. to provide a performance security in the form, amounts, and within the times prescribed in the PBDs;
- c. to abide by the Bid Validity Period specified in the PBDs and it shall remain binding upon us at any time before the expiration of that period.

[Insert this paragraph if Foreign-Assisted Project with the Development Partner:
Commissions or gratuities, if any, paid or to be paid by us to agents relating to this Bid, and to contract execution if we are awarded the contract, are listed below:

Name and address Amount and Purpose of agent Currency Commission or gratuity

(if none, state "None")]

Until a formal Contract is prepared and executed, this Bid, together with your written acceptance thereof and your Notice of Award, shall be binding upon us.

We understand that you are not bound to accept the Lowest Calculated Bid or any Bid you may receive.

We certify/confirm that we comply with the eligibility requirements pursuant to the PBDs.

The undersigned is authorized to submit the bid on behalf of *[name of the bidder]* as evidenced by the attached *[state the written authority]*.

We acknowledge that failure to sign each and every page of this Bid Form, including the attached Schedule of Prices, shall be a ground for the rejection of our bid.

Name: _____

Legal capacity: _____

Signature: _____

Duly authorized to sign the Bid for and behalf of: _____

Date: _____

***Statement of Single Largest Completed Contract
which is similar in nature***

(indicate only one)

Business Name: _____

Business Address: _____

Name of the Contract	Date of the Contract	Contract Duration	Owner's Name & Address	Kinds of Goods	Amount of Completed Contract	Date of Delivery	End User's Acceptance/Official Receipt(s)/Sales Invoice issued for the Contract

Submitted by : _____
(Printed Name & Signature)

Designation: _____

Date: _____

Note: Cut-off date is pre-bid date (_____)

***List of all Ongoing Government & Private Contracts
including Contracts awarded but not yet started***

Business Name: _____

Business Address: _____

Name of the Contract	Date of the Contract	Contract Duration	Owner's Name & Address	Kinds of Goods	Amount of Contract	Value of Outstanding Contract	Date of Delivery	End User's Acceptance/Official Receipt(s)/Sales Invoice issued for the Contract
<u>Government</u>								
<u>Private</u>								

Submitted by : _____

(Printed Name & Signature)

Designation: _____

Date: _____

Instructions:

- i. State all ongoing contracts including those awarded but not yet started.
- ii. If there is no ongoing contract including awarded but not yet started as of the aforementioned period, state none or equivalent term.
- iii. The total amount of the ongoing and awarded but not yet started contracts should be consistent with those used in the Net Financial Contracting Capacity(NFCC)incase an NFCC is submitted as an eligibility document.

Contract Agreement Form

THIS AGREEMENT made the ____ day of _____ 20 ____ between [name of *PROCURING ENTITY*] of the Philippines(hereinafter called “the Entity”) of the one part and [name of *Supplier*] of [city and country of *Supplier*] (hereinafter called “the Supplier”) of the other part:

WHEREAS the Entity invited Bids for certain goods and ancillary services, viz., [brief description of goods and services] and has accepted a Bid by the Supplier for the supply of those goods and services in the sum of [contract price in words and figures] (hereinafter called “the Contract Price”).

NOW THIS AGREEMENT WITNESSETH AS FOLLOWS:

1. In this Agreement words and expressions shall have the same meanings as are respectively assigned to them in the Conditions of Contract referred to.
2. The following documents shall be deemed to form and be read and construed as part of this Agreement, viz.:
 - (a) the Supplier’s Bid, including the Technical and Financial Proposals, and all other documents/statements submitted(e.g. bidder’s response to clarifications on the bid), including corrections to the bid resulting from the Procuring Entity’s bid evaluation;
 - (b) the Schedule of Requirements;
 - (c) the Technical Specifications;
 - (d) the General Conditions of Contract;
 - (e) the Special Conditions of Contract;
 - (f) the Performance Security; and
 - (g) the Entity’s Notice of Award.
3. In consideration of the payments to be made by the Entity to the Supplier as hereinafter mentioned, the Supplier hereby covenants with the Entity to provide the goods and services and to remedy defects therein in conformity in all respects with the provisions of the Contract
4. The Entity hereby covenants to pay the Supplier in consideration of the provision of the goods and services and the remedying of defects therein, the Contract Price or such other sum as may become payable under the provisions of the contract at the time and in the manner prescribed by the contract.

IN WITNESS where of the parties hereto have caused this Agreement to be executed in accordance with the laws of the Republic of the Philippines on the day and year first above written.

Signed, sealed, delivered by _____ the _____ (for the Entity)

Signed, sealed, delivered by _ the ___ (for the Supplier)

Omnibus Sworn Statement

REPUBLIC OF THE PHILIPPINES)
CITY/MUNICIPALITY OF _____) S.S.

AFFIDAVIT

I, *[Name of Affiant]*, of legal age, *[Civil Status]*, *[Nationality]*, and residing at *[Address of Affiant]*, after having been duly sworn in accordance with law, do hereby depose and state that:

1. **Select one, delete the other:**

If a sole proprietorship: I am the sole proprietor or authorized representative of *[Name of Bidder]* with office address at *[address of Bidder]*;

If a partnership, corporation, cooperative, or joint venture: I am the duly authorized and designated representative of *[Name of Bidder]* with office address at *[address of Bidder]*;

2. **Select one, delete the other:**

If a sole proprietorship: As the owner and sole proprietor, or authorized representative of *[Name of Bidder]*, I have full power and authority to do, execute and perform any and all acts necessary to participate, submit the bid, and to sign and execute the ensuing contract for *[Name of the Project]* of the *[Name of the Procuring Entity]*, as shown in the attached duly notarized *Special Power of Attorney*;

If a partnership, corporation, cooperative, or joint venture: I am granted full power and authority to do, execute and perform any and all acts necessary to participate, submit the bid, and to sign and execute the ensuing contract for *[Name of the Project]* of the *[Name of the Procuring Entity]*, as shown in the attached *[state title of attached document showing proof of authorization (e.g., duly notarized Secretary's Certificate, Board/Partnership Resolution, or Special Power of Attorney, whichever is applicable)]*;

3. *[Name of Bidder]* is not “blacklisted” or barred from bidding by the Government of the Philippines or any of its agencies, offices, corporations, or Local Government Units, foreign government/foreign or international financing institution whose blacklisting rules have been recognized by the Government Procurement Policy Board;
4. Each of the documents submitted in satisfaction of the bidding requirements is an authentic copy of the original, complete, and all statements and information provided therein are true and correct;
5. *[Name of Bidder]* is authorizing the Head of the Procuring Entity or its duly authorized representative(s) to verify all the documents submitted;

6. **Select one, delete the rest:**

If a sole proprietorship: The owner or sole proprietor is not related to the Head of the Procuring Entity, members of the Bids and Awards Committee (BAC), the Technical Working Group, and the BAC Secretariat, the head of the Project Management Office or the end-user unit, and the project consultants by consanguinity or affinity up to the third civil degree;

If a partnership or cooperative: None of the officers and members of [Name of Bidder] is related to the Head of the Procuring Entity, members of the Bids and Awards Committee (BAC), the Technical Working Group, and the BAC Secretariat, the head of the Project Management Office or the end-user unit, and the project consultants by consanguinity or affinity up to the third civil degree;

If a corporation or joint venture: None of the officers, directors, and controlling stockholders of [Name of Bidder] is related to the Head of the Procuring Entity, members of the Bids and Awards Committee (BAC), the Technical Working Group, and the BAC Secretariat, the head of the Project Management Office or the end-user unit, and the project consultants by consanguinity or affinity up to the third civil degree;

7. [Name of Bidder] complies with existing labor laws and standards; and
8. [Name of Bidder] is aware of and has undertaken the following responsibilities as a Bidder:
- a) Carefully examine all of the Bidding Documents;
 - b) Acknowledge all conditions, local or otherwise, affecting the implementation of the Contract;
 - c) Made an estimate of the facilities available and needed for the contract to be bid, if any; and
 - d) Inquire or secure Supplemental/Bid Bulletin(s) issued for the [Name of the Project].
9. [Name of Bidder] did not give or pay directly or indirectly, any commission, amount, fee, or any form of consideration, pecuniary or otherwise, to any person or official, personnel or representative of the government in relation to any procurement project or activity.

IN WITNESS WHEREOF, I have hereunto set my hand this ___ day of ___, 20___ at _____, Philippines.

Bidder's Representative/Authorized Signatory

SUBSCRIBED AND SWORN to before me this ___ day of [month] [year] at [place of execution], Philippines. Affiant/s is/are personally known to me and was/were identified by me through competent evidence of identity as defined in the 2004 Rules on Notarial Practice (A.M. No. 02-8-13-SC). Affiant/s exhibited to me his/her [insert type of government

identification card used], with his/her photograph and signature appearing thereon, with no. _____ and his/her Community Tax Certificate No. _____ issued on ____ at _____.

Witness my hand and seal this ____ day of *[month]* *[year]*.

NAME OF NOTARY PUBLIC

Serial No. of Commission _____

Notary Public for _____ until _____

Roll of Attorneys No. _____

PTR No. _____ *[date issued]*, *[place issued]*

IBP No. _____ *[date issued]*, *[place issued]*

Doc. No. _____

Page No. _____

Book No. _____

Series of _____

* This form will not apply for WB funded project.

BID SECURING DECLARATION FORM

REPUBLIC OF THE PHILIPPINES)
CITY OF _____) S.S.

x-----x

BID SECURING DECLARATION Invitation to Bid:[Insert Reference number]

To: [Insert name and address of the Procuring Entity]

I/We³, the undersigned, declare that:

1. I/We understand that, according to your conditions, bids must be supported by a Bid Security, which may be in the form of a Bid-Securing Declaration.
2. I/We accept that: (a) I/we will be automatically disqualified from bidding for any contract with any procuring entity for a period of two (2) years upon receipt of your Blacklisting order; and, (b) I/we will pay the applicable fine provided under Section 6 of the Guidelines on the Use of Bid Securing Declaration, within fifteen (15) days from receipt of the written demand by the procuring entity for the commission of acts resulting to the enforcement of the bid securing declaration under Sections 23.1(b), 34.2, 40.1 and 69.1, except 69.1(f), of the IRR of RA 9184; without prejudice to other legal action the government may undertake.
3. I/We understand that this Bid Securing Declaration shall cease to be valid on the following circumstances:
 - (a) Upon expiration of the bid validity period, or any extension thereof pursuant to your request;
 - (b) I am/we are declared ineligible or post-disqualified upon receipt of your notice to such effect, and (i) I/we failed to timely file a request for reconsideration or (ii) I/we filed a waiver to avail of said right;
 - (c) I am/we are declared the bidder with the Lowest Calculated Responsive Bid, and I/we have furnished the performance security and signed the Contract.

IN WITNESS WHEREOF, I/We have hereunto set my/our hand/s this ____ day of [month] [year] at [place of execution].

³ Select one and delete the other. Adopt the same instruction for similar terms throughout the document.

*[Insert NAME OF BIDDER'S AUTHORIZED
REPRESENTATIVE]
[Insert Signatory's Legal Capacity]
Affiant*

SUBSCRIBED AND SWORN to before me this ____ day of *[month]* *[year]* at *[place of execution]*, Philippines. Affiant/s is/are personally known to me and was/were identified by me through competent evidence of identity as defined in the 2004 Rules on Notarial Practice (A.M. No. 02-8-13-SC). Affiant/s exhibited to me his/her *[insert type of government identification card used]*, with his/her photograph and signature appearing thereon, with no. _____ and his/her Community Tax Certificate No. _____ issued on ____ at _____.

Witness my hand and seal this ____ day of *[month]* *[year]*.

NAME OF NOTARY PUBLIC

Serial No. of Commission _____
Notary Public for _____ until _____
Roll of Attorneys No. _____
PTR No. _____ *[date issued]*, *[place issued]*
IBP No. _____ *[date issued]*, *[place issued]*

Doc. No. _____
Page No. _____
Book No. _____
Series of _____

Republic of the Philippines



Government Procurement Policy Board